

EVOLVE SKY PANEL

PROFESSIONAL SERIES LED PANEL LIGHT

LOW GLARE
UGR<19
OPTION AVAILABLE

UP TO
50%
ENERGY SAVING

HIGH
100lm/w
SYSTEM EFFICACY

LIFETIME OF
54,000+
HOURS TO L70

ULTRA-THIN DESIGN

FLICKER FREE DRIVER

EVEN LIGHT DISTRIBUTION

1.2M FLEX AND PLUG INCLUDED





HIGH QUALITY CONSTRUCTION AND PERFORMANCE

From the pressed backplate for increased strength, to the use of PMMA to avoid yellowing, the LED Sky Panel is built to a high standard to ensure a high performance.

A KIT FOR EVERYTHING



SURFACE KIT

RECESSED KIT

Whether you need your Sky Panel to be suspended, surface mounted or recessed we have the solution for your job.



A COMFORTABLE LIGHTING SOLUTION

LED panels have increased in light output over the last few years and with it, glare has become a problem. As a result, workplaces are wanting solutions to this issue.

Evolve's low glare panel's tackle this problem with an excellent UGR rating of <19. We are able to minimise the glare by using a Micro Prismatic diffuser to refocus the light downwards and out of direct eyesight. Creating a more comfortable environment to work in.

LED SKY PANEL LOW GLARE

LOW GLARE LED PANEL LIGHT

4000K
Colour Temperature

5 Year
Warranty

Low
UGR19 Rating

Dimmable
Options



FEATURES

- Low Glare UGR19 rating
- Smooth, even light distribution
- Long lasting, >54,000 hours life
- Flicker free
- Dimming options available
- 1.2m Flex and plug included

CODE	POWER	LUMEN OUTPUT	EFFICACY	DIMENSIONS
SKYPL6060CW LG	36W	3,600lm	100lm/W	596mm x 596mm x 11mm
SKYPL1230CW LG	36W	3,600lm	100lm/W	1196mm x 296mm x 11mm
SKYPL1260CW LG	50W	5,000lm	100lm/W	1196mm x 596mm x 11mm

LIGHTING DATA

LIFE SPAN @L70	>54,000hrs
CCT	4000K
CRI	>80
SDCM	<5
UGR	<19
BEAM ANGLE	90°

ELECTRICAL DATA

POWER SUPPLY	High efficiency LED driver
MAINS VOLTAGE	AC200-240V / 50-60 Hz
POWER FACTOR	>0.9
THD	<15%
FLICKER FREE	Yes
DIMMING OPTIONS	DALI, SwitchDim, 1-10V

DESIGN / CONSTRUCTION

BASE MATERIAL	Aluminium
DIFFUSER MATERIAL	PMMA/PS
FINISH	Powder Coated
COLOUR	White
SEISMIC RESTRAINTS	Yes (2m Stainless cable)

TECHNICAL DATA

IP RATING	IP40
IK RATING	IK04
OPERATING TEMP	-20°C to +45°C
CONNECTION	1.2m Flex and plug
PROTECTION CLASS	Class 2
WARRANTY	5 Years

LED SKY PANEL LOW GLARE

ULTRA LOW GLARE LED PANEL LIGHT

PHOTOMETRIC DIAGRAM

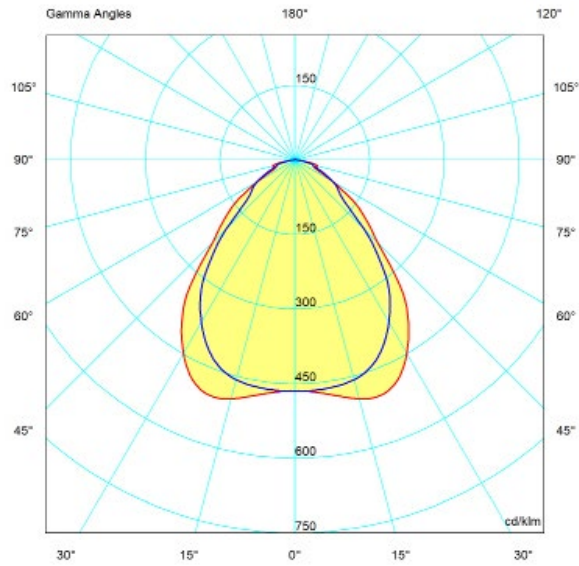

IMAGES



Close Up



Rear

LED SKY PANEL

HIGH PERFORMANCE LED PANEL LIGHT



4000K/5000K
Colour Temperature



5 Year
Warranty



Flicker Free
Driver



Dimmable
Options



FEATURES

- Smooth, even light distribution
- Long lasting, >54,000 hours life
- Flicker free
- Dimming options available
- 1.2m Flex and plug included

CODE	POWER	CCT	LUMEN OUTPUT	EFFICACY	DIMENSIONS
SKYPL6060CW	36W	4000K	3,600lm	100lm/W	596mm x 596mm x 11mm
SKYPL6060NW	36W	5000K	3,600lm	100lm/W	596mm x 596mm x 11mm
SKYPL1230CW	36W	4000K	3,600lm	100lm/W	1196mm x 296mm x 11mm
SKYPL1260CW	50W	4000K	5,000lm	100lm/W	1196mm x 596mm x 11mm
SKYPL1260NW	50W	5000K	5,000lm	100lm/W	1196mm x 596mm x 11mm

LIGHTING DATA

LIFE SPAN @L70	>54,000hrs
CCT	4000K/5000K
CRI	>80
SDCM	<5
UGR	<22
BEAM ANGLE	110°

ELECTRICAL DATA

POWER SUPPLY	High efficiency LED driver
MAINS VOLTAGE	AC200-240V / 50-60 Hz
POWER FACTOR	>0.95
THD	<15%
FLICKER FREE	Yes
DIMMING OPTIONS	DALI, SwitchDim, 1-10V

DESIGN / CONSTRUCTION

BASE MATERIAL	Aluminium
DIFFUSER MATERIAL	PMMA/PS
FINISH	Powder Coated
COLOUR	White
SEISMIC RESTRAINTS	Yes (2m Stainless cable)

TECHNICAL DATA

IP RATING	IP40
IK RATING	IK04
OPERATING TEMP	-20°C to +45°C
CONNECTION	1.2m Flex and plug
PROTECTION CLASS	Class 2
WARRANTY	5 Years

SKY PANEL SURFACE KIT

SCREWLESS SURFACE MOUNTING KIT

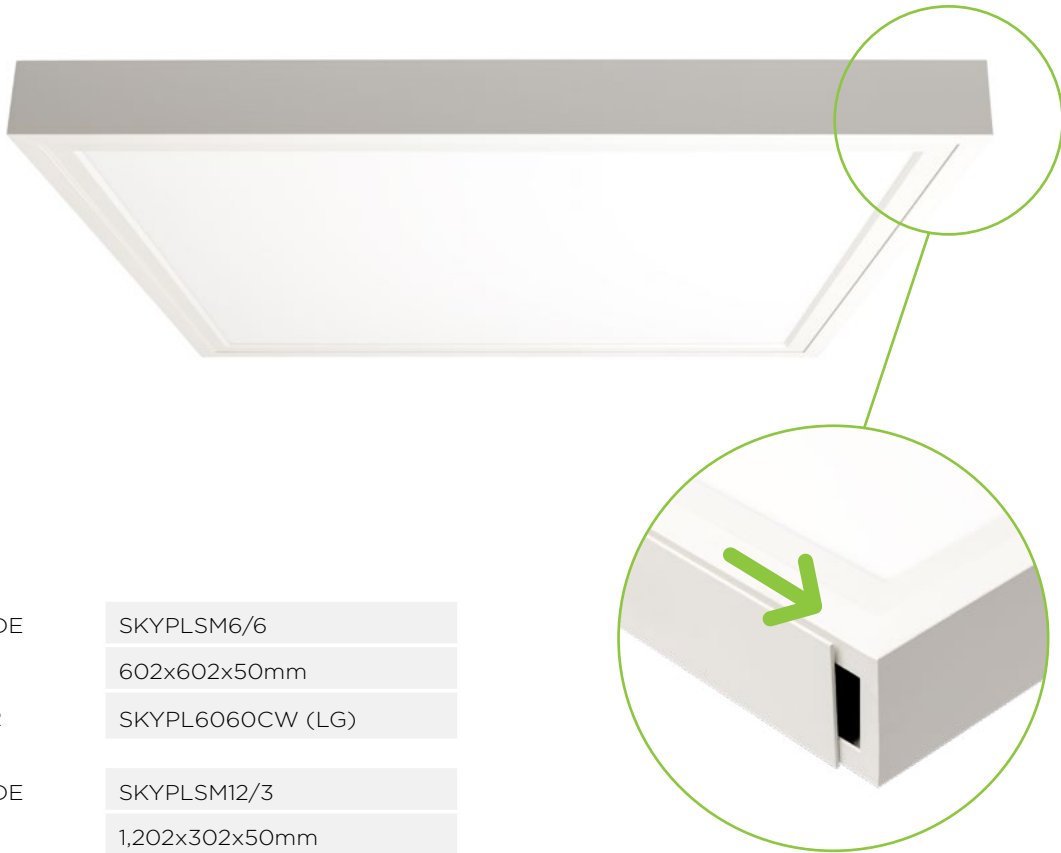

PRODUCT CODE	SKYPLSM6/6
SIZE	602x602x50mm
SUITABLE FOR	SKYPL6060CW (LG)

PRODUCT CODE	SKYPLSM12/3
SIZE	1,202x302x50mm
SUITABLE FOR	SKYPL1230CW (LG)

PRODUCT CODE	SKYPLSM12/6
SIZE	1,202x602x50mm
SUITABLE FOR	SKYPL1260CW (LG)

MATERIAL	Steel
COATING	Powder Coated
COLOUR	White
ASSEMBLY	Pre assembled, no screws

INSTALLATION

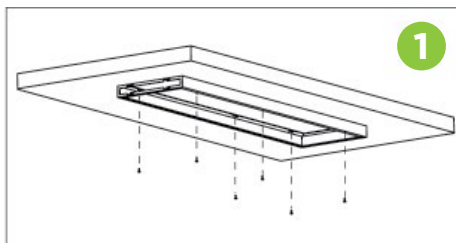

Fix the frame to the ceiling with screws

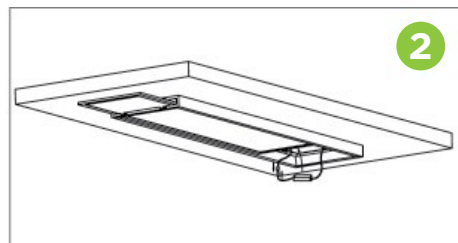

Put the panel into the frame

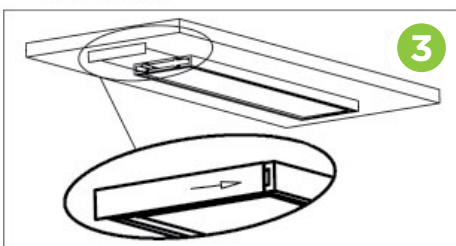

Assemble the side segment

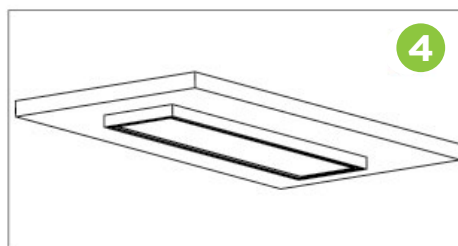

Finished

SKY PANEL RECESSED KIT

RECESSED MOUNTING FRAME



PRODUCT CODE	SKYPLRF6/6
SIZE	632x632x31mm
CUT OUT	615x615mm
SUITABLE FOR	SKYPL6060CW (LG)

PRODUCT CODE	SKYPLRF12/3
SIZE	1,232x332x31mm
CUT OUT	1,215x315mm
SUITABLE FOR	SKYPL1230CW (LG)

PRODUCT CODE	SKYPLRF12/6
SIZE	1,232x632x31mm
CUT OUT	1,215x615mm
SUITABLE FOR	SKYPL1260CW (LG)

MATERIAL	Steel
COATING	Powder Coated
COLOUR	White
ASSEMBLY	Pre assembled

INSTALLATION

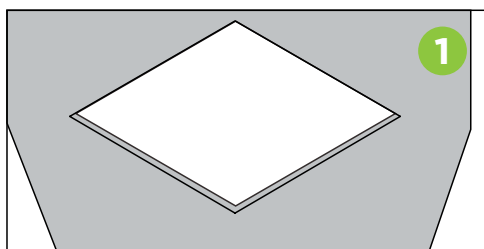

Cut a hole in the ceiling

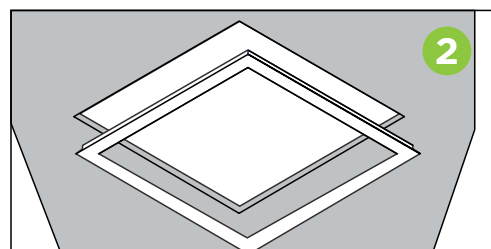

Fix the frame into the hole

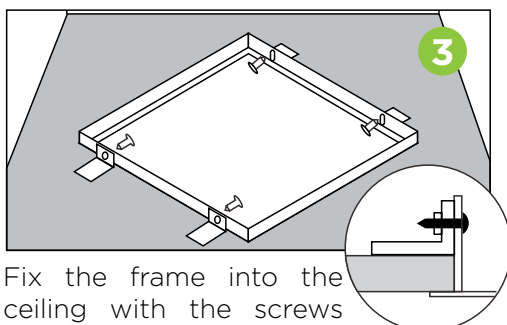

Fix the frame into the ceiling with the screws and "L" accessory

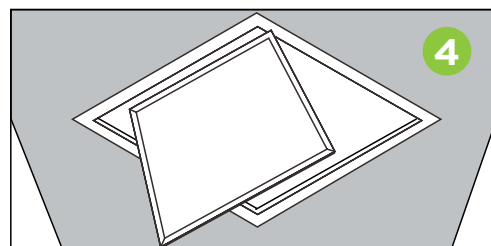

Put the panel into the frame

SKY PANEL SUSPENSION KIT



CODE
MATERIAL
CABLE LENGTH
PIECES PER SET

SKYPLSUS
Stainless Steel
1.2m
4

INSTALLATION

